

# ZB4BP4

red projecting pushbutton head Ø22 spring  
return unmarked



## Main

Commercial Status	Commercialised
Range of product	Harmony XB4
Product or component type	Head for non-illuminated pushbutton
Device short name	ZB4
Bezel material	Chromium plated metal
Mounting diameter	22 mm
Sale per indivisible quantity	1
Shape of signaling unit head	Round
Type of operator	Spring return
Operator profile	Red projecting unmarked
Operator additional information	Clear boot
Additional information	Not compatible with legend holder

## Complementary

CAD overall width	30 mm
CAD overall height	30 mm
CAD overall depth	35 mm
Mechanical durability	5000000 cycles
Electrical composition code	C15 for 1 contacts using single blocks in front mounting C11 for <= 3 contacts using single blocks in front mounting C2 for <= 9 contacts using single and double blocks in front mounting C1 for <= 9 contacts using single blocks in front mounting

## Environment

Protective treatment	TH
Ambient air temperature for storage	-40...70 °C
Ambient air temperature for operation	-25...70 °C
Class of protection against electric shock	Class I conforming to IEC 60536
IP degree of protection	IP69K conforming to IEC 60529
NEMA degree of protection	NEMA 4X NEMA 13
IK degree of protection	IK03 conforming to IEC 50102
Standards	CSA C22-2 No 14 EN/IEC 60947-1 EN/IEC 60947-5-1 EN/IEC 60947-5-4 EN/IEC 60947-5-5 JIS C 4520 UL 508
Product certifications	BV CSA DNV GL LROS (Lloyds register of shipping) RINA UL listed
Vibration resistance	5 gn (f = 2...500 Hz) conforming to IEC 60068-2-6
Shock resistance	50 gn for 11 ms half sine wave acceleration conforming to IEC 60068-2-27 30 gn for 18 ms half sine wave acceleration conforming to IEC 60068-2-27

## Contractual warranty

---

Period	18 months
--------	-----------

---

Dimensions

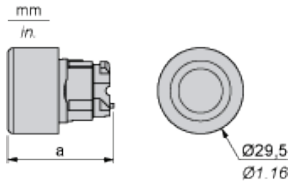

	a in mm	a in in.
ZB4BP••	36.5	1.44
ZB4BP•S	33	1.30
ZB4BP•83	32	1.26
ZB4BP•	35	1.38

Panel Cut-out for Pushbuttons, Switches and Pilot Lights (Finished Holes, Ready for Installation)

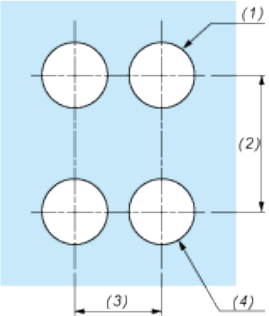
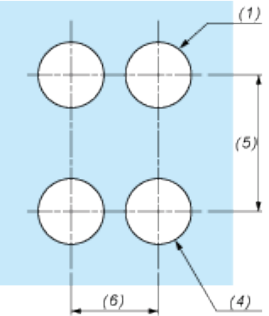
Connection by Screw Clamp Terminals or Plug-in Connectors or on Printed Circuit Board	Connection by Faston Connectors
	
<p>(1) Diameter on finished panel or support                  (2) 40 mm min. / 1.57 in. min.                  (3) 30 mm min. / 1.18 in. min.                  (4) <math>\varnothing 22.5 \text{ mm} / 0.89 \text{ in.}</math> recommended (<math>\varnothing 22.3 \text{ mm}_0^{+0.4} / 0.88 \text{ in.}_0^{+0.016}</math>)                  (5) 45 mm min. / 1.78 in. min.                  (6) 32 mm min. / 1.26 in. min.</p>	

Pushbuttons, Switches and Pilot Lights for Printed Circuit Board Connection

Panel Cut-outs (Viewed from Installer's Side)

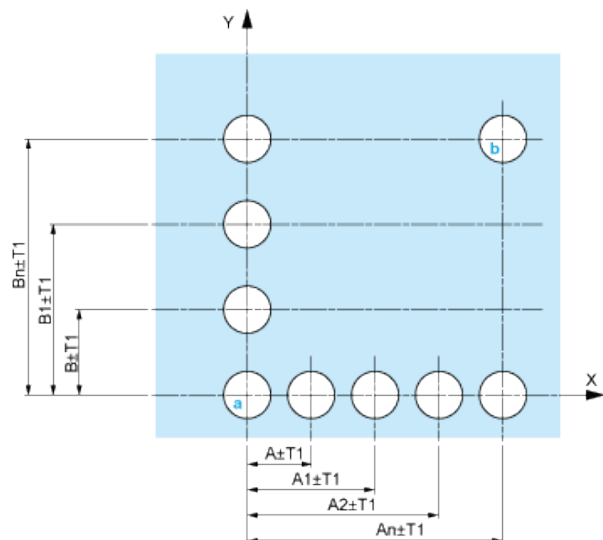

- A: 30 mm min. / 1.18 in. min.  
 B: 40 mm min. / 1.57 in. min.



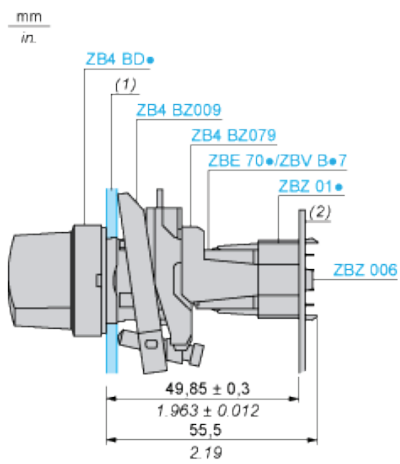

- (1) Panel  
(2) Printed circuit board

### Mounting of Adapter (Socket) ZBZ 01•

- 1 2 elongated holes for ZBZ 006 screw access
- 2 1 hole  $\varnothing 2.4 \text{ mm} \pm 0.05 / 0.09 \text{ in.} \pm 0.002$  for centring adapter ZBZ 01•
- 3  $8 \times \varnothing 1.2 \text{ mm} / 0.05 \text{ in.}$  holes
- 4 1 hole  $\varnothing 2.9 \text{ mm} \pm 0.05 / 0.11 \text{ in.} \pm 0.002$ , for aligning the printed circuit board (with cut-out marked a)
- 5 1 elongated hole for aligning the printed circuit board (with cut-out marked b)
- 6 4 holes  $\varnothing 2.4 \text{ mm} / 0.09 \text{ in.}$  for clipping in adapter ZBZ 01•

Dimensions An + 18.1 relate to the  $\varnothing 2.4 \text{ mm} \pm 0.05 / 0.09 \text{ in.} \pm 0.002$  holes for centring adapter ZBZ 01•.

---

Electrical Composition Corresponding to Code C1

---



---

Electrical Composition Corresponding to Code C2

---



---

Electrical Composition Corresponding to Codes C9, C11, SF1 and SR1

---



---

Electrical Composition Corresponding to Code C15

---

1 N/O

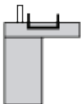

1 N/C

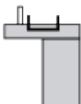

1 N/O + N/C or 1 N/O + N/O or 1 N/C + N/C

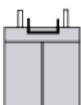

---

Legend

---

Single contact



Double contact



Light block



Possible location

